

THANK YOU!

Thank you for visiting my account and for your recent download.

I hope these "letter X is for" activities meet your expectations and needs. It saves you time and is super helpful for your child at home or kids in the classroom.

If you have any questions, suggestions, or notice an error, please email me at anna@learngrowaspire.com so I can make it right.

Thank you so much for your support.

Anna

Stay Connected For Exclusive Printables!

[Subscribe to my email list to be notified when I add new resources and receive FREE exclusive printables and more!](#)

LET'S STAY CONNECTED!



[SEE WHAT'S HAPPENING ON THE BLOG](#)



[PINTEREST](#)



[FACEBOOK](#)



[NEW INSTAGRAM ACCOUNT](#)



Learn Grow Aspire was created to support parents, caregivers, and elementary classroom teachers with teaching resources and inspirations they can implement in their homeschool or classrooms.

MEET THE FACE BEHIND LEARN GROW ASPIRE

Hey, I'm Anna. Author and creator of Learn Grow Aspire resources. I love creating activities and printables that inspire a love for learning and make life easier for busy parents and teachers.



xoxo Anna

Trace the words for each picture and color the image.

X is for



xmas

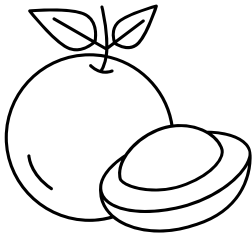

ximenia

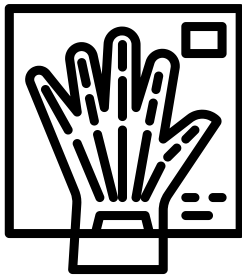

x-ray

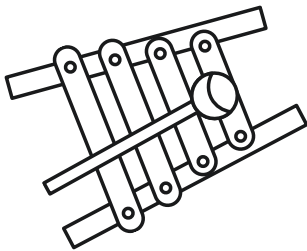

xylophone

Letter of the Week

Xx

Name _____

X is for

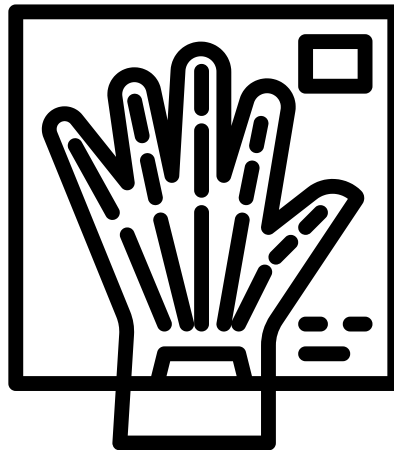

x-ray

X is for

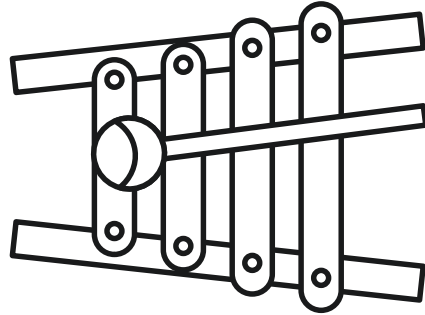

xylophone.

X is for

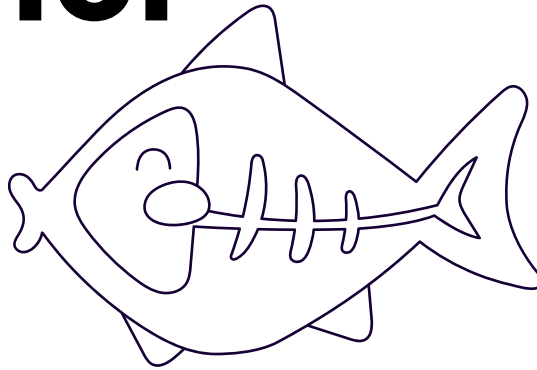

x-ray fish

X is for

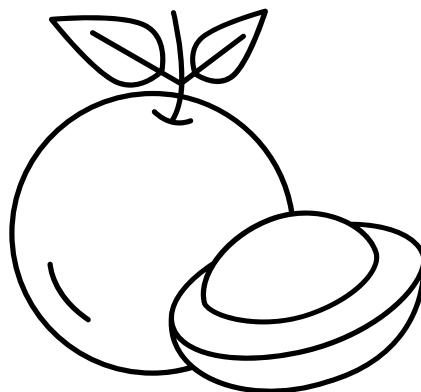

xmas.

X is for



xmas.